



L.E. Johnson Products, Inc.  
 2100 Sterling Ave.  
 Elkhart, IN 46516  
 Ph: (574) 293-5664  
 Fax: (574) 294-4697  
 info@johnsonhardware.com  
 www.johnsonhardware.com



**1138**

Residential Bypass Track and Hardware  
 for 1 3/8" Thick Panels to 50 lbs. per Panel

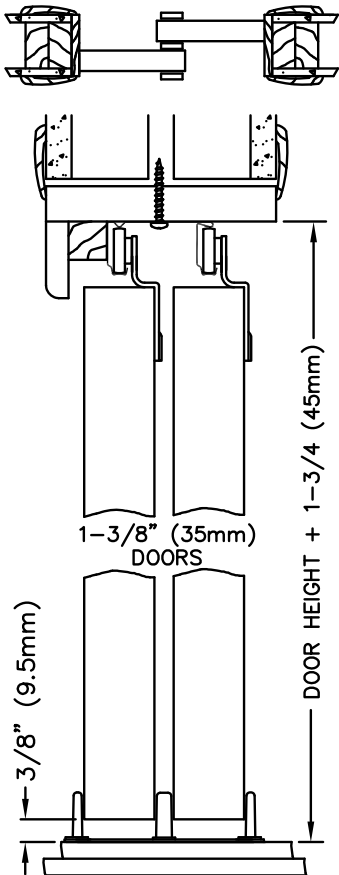

Track is precision rolled heavy duty steel with convex rails. Hangers are heavy-gauge steel with zinc and yellow zinc trivalent plating, and in reverse positions will accommodate 1 3/8" doors. Wheels are 7/8" dia. molded from nylon and machined for size, smoothness and balance. Adjustable door guide is woodtone finished steel with woodtone nylon floating guides. Pulls are 3/4" dia. satin nickel plated. Sets are available in single pack or in bulk.

**1138 Exceptional Features**

**Unique Track Design**

Convex track rails are designed to provide minimum friction and have parallel dust-catching traps. Rails also are designed to prevent doors from jumping the track. Enamel finish blends the track with any decor.

**Exclusive Balanced-Wheel Hangers**

These uniquely engineered hangers with machine turned and balanced wheels for 1 3/8" doors. They also adjust door up or down without removing or changing screws. The three-point fastening holds door positively to prevent slipping.

**Adjustable Door Guide**

One-piece metal guide assembly adjusts laterally for quick plumb. Nylon guide posts are a full 1" high. Center guide and outside guides swivel automatically allowing even warped doors to glide smoothly without binding. A 180 degree turn of the outside guides widens or narrows door clearance.



**Complete Hardware Set**

1138 Track	2238 Hanger (3/8" Offset)
2135 Door Guide	15 Pull (3/4" dia.)
2255 Stop Kit (4 Door Sets Only)	Plus all screws and instructions



## 1138 Installation Overview

### FINISHED OPENING WIDTHS (FROM INSIDE TO INSIDE OF FINISHED DOOR JAMBS)

#### 2 DOOR

MULTIPLY DOOR WIDTH BY 2, SUBTRACT 1"



#### 3 DOOR

MULTIPLY DOOR WIDTH BY 3, SUBTRACT 2"

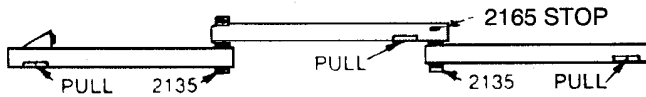

#### 4 DOOR

MULTIPLY DOOR WIDTH BY 4, SUBTRACT 2"

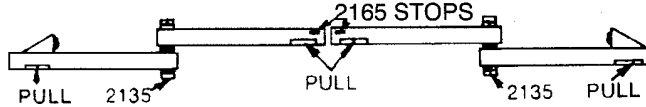

### FOR 1-3/8" DOORS

Mount track as shown in diagram at right. Fasten hangers on back side of rear door and drill doors for pulls, 36" from bottom of door.

NOTE: To obtain full adjustment possibilities, screws must be located at TOP of each slot as shown in Fig. 1. Raise all hangers to top adjustment as shown in Fig. 2 when installing doors.

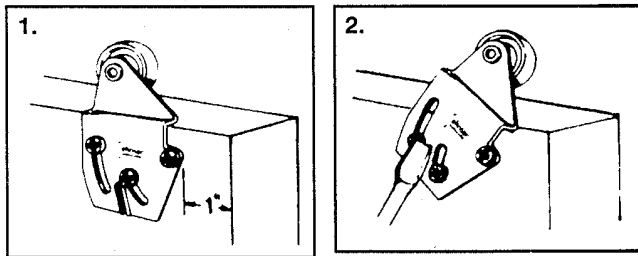

**MOUNT REAR DOOR FIRST** by tilting door back and resting hangers on rear rail.

**MOUNT FRONT DOOR** same way by tilting back and placing hangers on front rail.

**DOOR GUIDE** is located by moving both doors to jamb on one side, positioning guide between doors as shown, and fastening to floor. If floor is carpeted, use Johnson 2136 CARPET RISER.

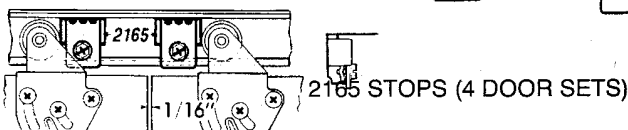
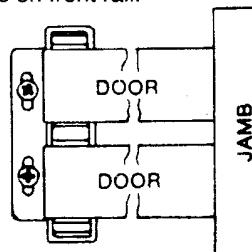

### Optional Accessories

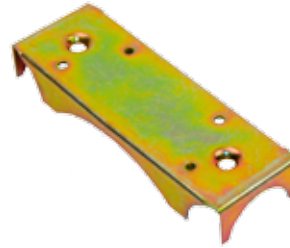

2136 Carpet Riser  
Eliminates cutting carpet

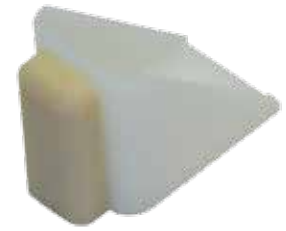

2155 Rear Door Stop  
Prevents the rear door from opening beyond the pull

